

FQ60XDE



Product Family	Refrigerator
Installation	Free standing
Category	4 Doors
Reference width	Higher than 80 cm
Reference height	160 - 200 cm
Sistema Total No - Frost	Yes
Cooling type	Total No Frost - Double Cooling system
Defrost	Automatic
Hinge type	Standard
EAN code	8017709337698



Aesthetics



Aesthetic	Universale	Side material	Steel
Colour	Inox Look	Side colour	Silver
Design	Flat	Logo	Applied
Finishing	Fingerproof	Door shelves profile color	Silver
Material	Steel Effect	Drawers profile color	Silver
Door steel type	Finger proof	Color of glass shelf profile	Silver
Handle	External	Display	LED
Handle type	Fixed	Display position	Esterno (su porta)
Handle colour	Stainless steel	Alternative colours available	White, Black
Logo colour	Chrome		

Refrigerator compartment features



Number of compartments	3	Crisper Cover	Yes
Compartment types	Low temperature compartment, Fruit and vegetable compartment	Type of crisper/vegetable drawers cover	Glass
No. of adjustable shelves	2	No. of lights refrigerator compartment	2
Number of fruit and vegetables drawers	2	Low temperature compartment	Yes
Shelves material	Glass	Internal light in fridge	Yes

Type of crisper/vegetable drawers cover	On sliding rails	Type of internal light (fridge)	LED
---	------------------	---------------------------------	-----

Refrigerator Inner Door

No. of door shelves with transparent cover	2	No. of bottle shelves	2
Number of adjustable door shelves	2		

Other Refrigerator features



Humidity Control	Yes, manual	MultiFlow	Yes
Accessories	Egg tray	Fan	Yes
Natural Plus Blu Light	Yes	Antibacterial odour filter	Yes

Freezer compartment features

Number of drawers	4	Type of shelves	Glass
No. of shelves	2		

Other Freezer features



Accessories	2 ice boxes	Fast freezing compartment	Yes
-------------	-------------	---------------------------	-----

Other technical features

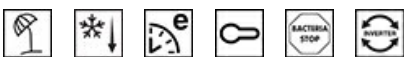

Functions display	Holiday, Fast freezing, Fast cooling, ECO, Control lock
Fast freezing button	Yes
Temperature alarm lamp	Yes
Door open alarm	Yes
Temperature Alarm	Yes
Antibacterial Gasket	Yes
Type of temperature control	Electronic
No. of compressors	1
Refrigerant gas type	R600a
Type of compressor	Inverter
Foam agent	Cyclopentane

Performance / Energy Label - Reg. 2019

Annual energy consumption	338 kWh/a	Airborne acoustical noise emissions	37 dB(A) re 1 pW
Energy efficiency class	E	Temperature Rise Time	10 h
Airborne acoustical noise emission class	C	4 star - Freezing capacity	4.6 kg/24h
Total net volume	541 l	Freezer (4-star) (1) - Freezing capacity	4.6 kg/24h
Sum of the volumes of the frozen compartment(s)	165 l	Climate class	SN, N, ST, T
Sum of the volumes of the chill compartment(s) and the unfrozen compartment(s)	376 l	EI	100 %

Electrical Connection







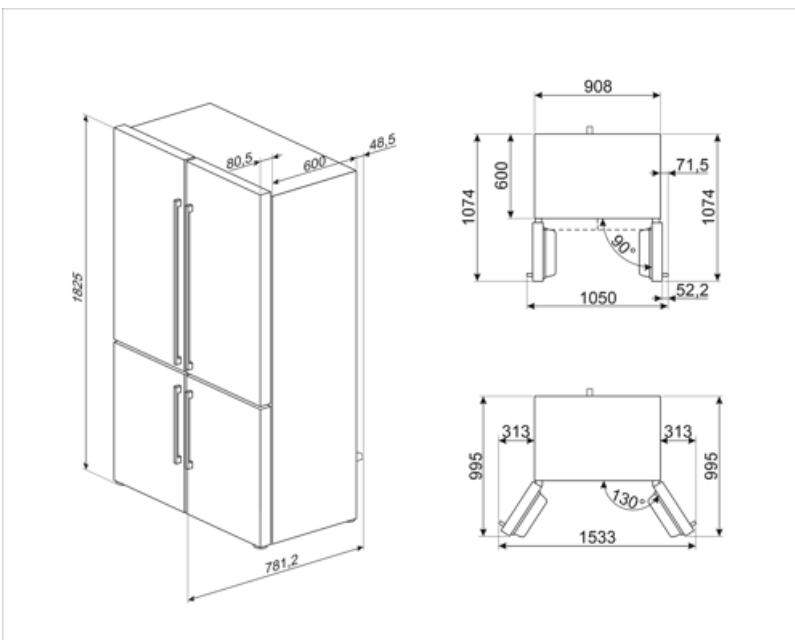







Electrical connection rating	200 W	Frequency (Hz)	50 Hz
Current	0.8 A	Power supply cable length	240 cm
Voltage (V)	220-240 V	Plug	(F;E) Schuko

Logistic Information

Width	908 mm	Product width with maximum doors opening	1533 mm
Height	1820 mm	Product depth with doors open at 90°	1074 mm



Symbols glossary

	The automatic defrost system works by automatically defrosting at regular intervals eliminating the need to defrost altogether.		Antibacterial treatment: antibacterial treatment to ensure better hygiene.
	Child lock: some models are fitted with a device to lock the programme/cycle so it cannot be accidentally changed.		Energy efficiency class E
	LED display: to show programmes, functions and options selected and the time to the end of the cycle.		Economical mode: Analyzes fridge functioning during the activation and optimizes the operating cycle in order to reduce power consumption.
	Ventilated: Forced distribution of cold air in the refrigerator compartment, which allows even temperature distribution within the fridge.		Fast freezing: The fast freezing function brings the temperature of the compartment down when activated a few hours prior to usage.
	Fingerprint proof stainless steel: Fingerprint proof stainless steel keeps stainless steel looking as good as new.		Power saving mode: The power saving mode allows you to disable the refrigerator and keep the freezer working.
	LED interior lighting: is a more energy efficient and long lasting way of illuminating the interior of the appliance.		Smeg's evolution towards more intelligent and eco-friendly models has led to the choice of Inverter technology, which significantly reduces consumption.
	Multiflow Cooling System: the Multiflow ventilation system allows an even distribution of cool air around the fridge cabinet.		Natural Plus Blu Light: This unique Natural Plus Blu Light system works with nature to increase the storage time of fruit and vegetables.